

CURRENT 15.0 Ampere
 VOLTAGE RANG 50 to 1000 Volts

KBPC1501 THRU KBPC1510

Features

- This series is SGS listed under the Recognized Component Index, file number SZXEC1902259902
- Surge overload ratings to 300 amperes
- The plastic material used carries Underwriters Laboratory flammability recognition 94V-0
- Universal 4-way terminals, snap-on, wrap-around, solder or P.C. Board mounting
- High temperature soldering guaranteed 265°C/10 seconds at 5 lbs (2.3kg) tension

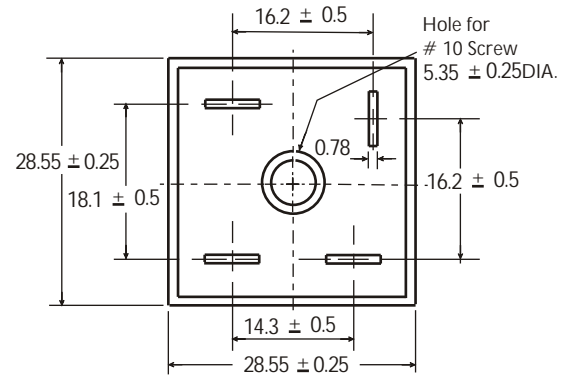

Mechanical Data

Case: Metal case
 Terminals: Plated .25" (6.53mm) Faston
 Mounting Position: Bolt down on heat-sink with silicone thermal compound between bridges and mounting surface for maximum heat transfer efficiency
 Mounting Position: Any
 Weight: 1.024 ounce, 29 grams (approx)

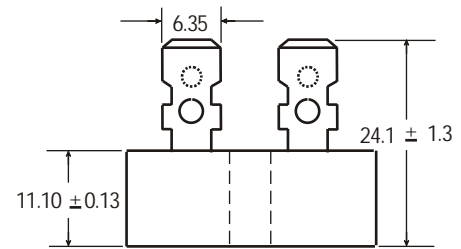

Dimensions in millimeters(1mm =0.0394")

Maximum Ratings & Thermal Characteristics

Rating at 25°C ambient temperature unless otherwise specified, Resistive or Inductive load, 60 Hz.
 For Capacitive load derate current by 20%.

Parameter	Symbol	KBPC 15005	KBPC 1501	KBPC 1502	KBPC 1504	KBPC 1506	KBPC 1508	KBPC 1510	unit
Maximum repetitive peak reverse voltage	VRRM	50	100	200	400	600	800	1000	V
Maximum RMS bridge input voltage	VRMS	35	70	140	280	420	560	700	V
Maximum DC blocking voltage	VDC	50	100	200	400	600	800	1000	V
Maximum average forward rectified output current at TA=55°C	IF(AV)	15							A
Peak forward surge current single sine-wave superimposed on rated load (JEDEC Method)	IFSM	300							A
Rating for fusing (t<8.3ms)	I ² t	374							A ² sec
Typical thermal resistance per element (1)	ReJA	2.1							°C / W
Isolation voltage from case to leads	Vis	2500							Vac
Operating junction and storage temperature range	TJ, TSTG	-55 to + 150							°C

Electrical Characteristics

Rating at 25°C ambient temperature unless otherwise specified. Resistive or Inductive load, 60Hz.
 For Capacitive load derate by 20 %.

Parameter	Symbol	KBPC 15005	KBPC 1501	KBPC 1502	KBPC 1504	KBPC 1506	KBPC 1508	KBPC 1510	Unit
Maximum instantaneous forward voltage drop per leg at 7.5A	VF	1.1							V
Maximum DC reverse current at rated TA =25°C DC blocking voltage per element TA =125°C	IR	10 500							μA

Notes: (1)Thermal resistance from Junction to Ambient on P.C.board mounting.

CURRENT 15.0 Ampere
 VOLTAGE RANG 50 to 1000 Volts

KBPC1501 THRU KBPC1510

Rating and Characteristic Curves ($T_A=25^{\circ}\text{C}$ Unless otherwise noted)

Fig. 1 Derating Curve for Output Rectified Current

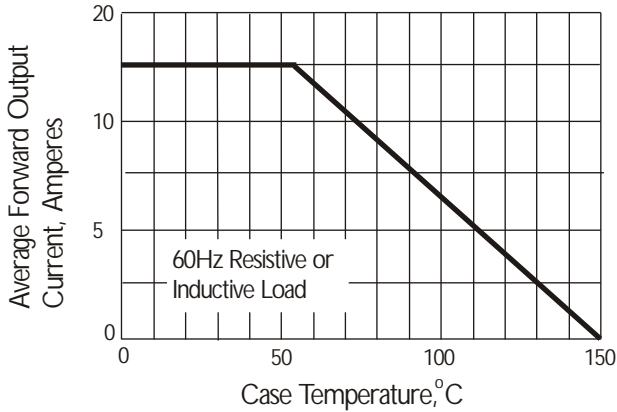

Fig. 2 Maximum Non-repetitive Peak Forward Surge Current

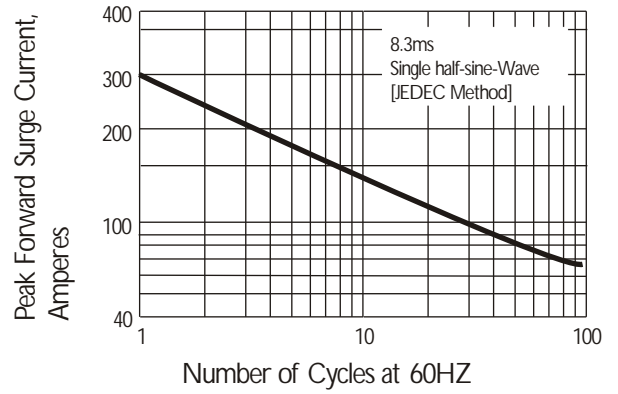

Fig. 3 Typical Instantaneous Forward Characteristics

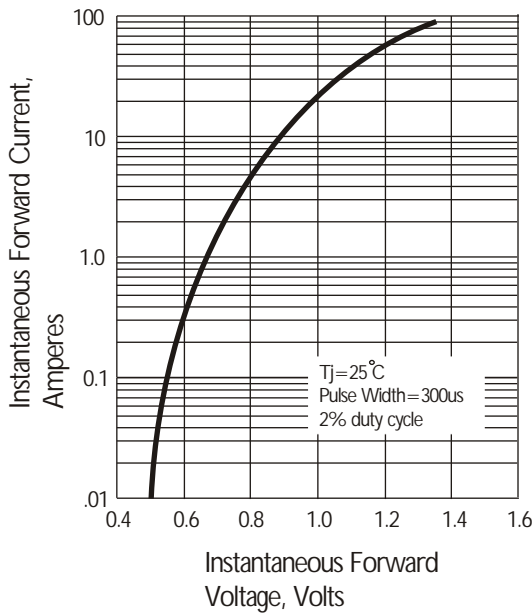

Fig. 4 Typical Reverse Characteristics at $T_J=25^{\circ}\text{C}$

